

CAP 10

(City Autonomous Patrol Robot 10)

The City College of New York
The City University of New York
Grove School of Engineering



Team Members

Royneal Rayess
Giovanny Giraldo
Henry Gonzales
Faiz Hasanuzzaman

Required Faculty Advisor Statement:

I certify that the engineering design of the vehicle described in this report, CAP 10, has been significant and that each team member has earned four semester hours, of senior design credit for their work on this project.

A handwritten signature in black ink, appearing to read "Xiao Jizhong".

Professor **Jizhong Xiao**

Department of Electrical Engineering, The City College of New York

Introduction

The City College of New York is proud to present CAP 10 for entry into the 18th Annual Intelligent Ground Vehicle Competition. The CAP 10 team is integrated by multi-disciplinary engineering students. This year our main goal was to reengineer ELVIS, which was last year's robot, and generate a new model with significant improvements to both hardware and software within a reasonable budget. Physically, we have rebuilt the platform, improving aesthetics, weatherproofing yet maintaining functionality in design. We have improved the software in terms of safety, tracking orientation, computer vision, and GPS waypoints. This year, our robot has more reliable and smarter software as well as more thought out structure that better distributes electrical circuitry and electronics for easier servicing and repairs.

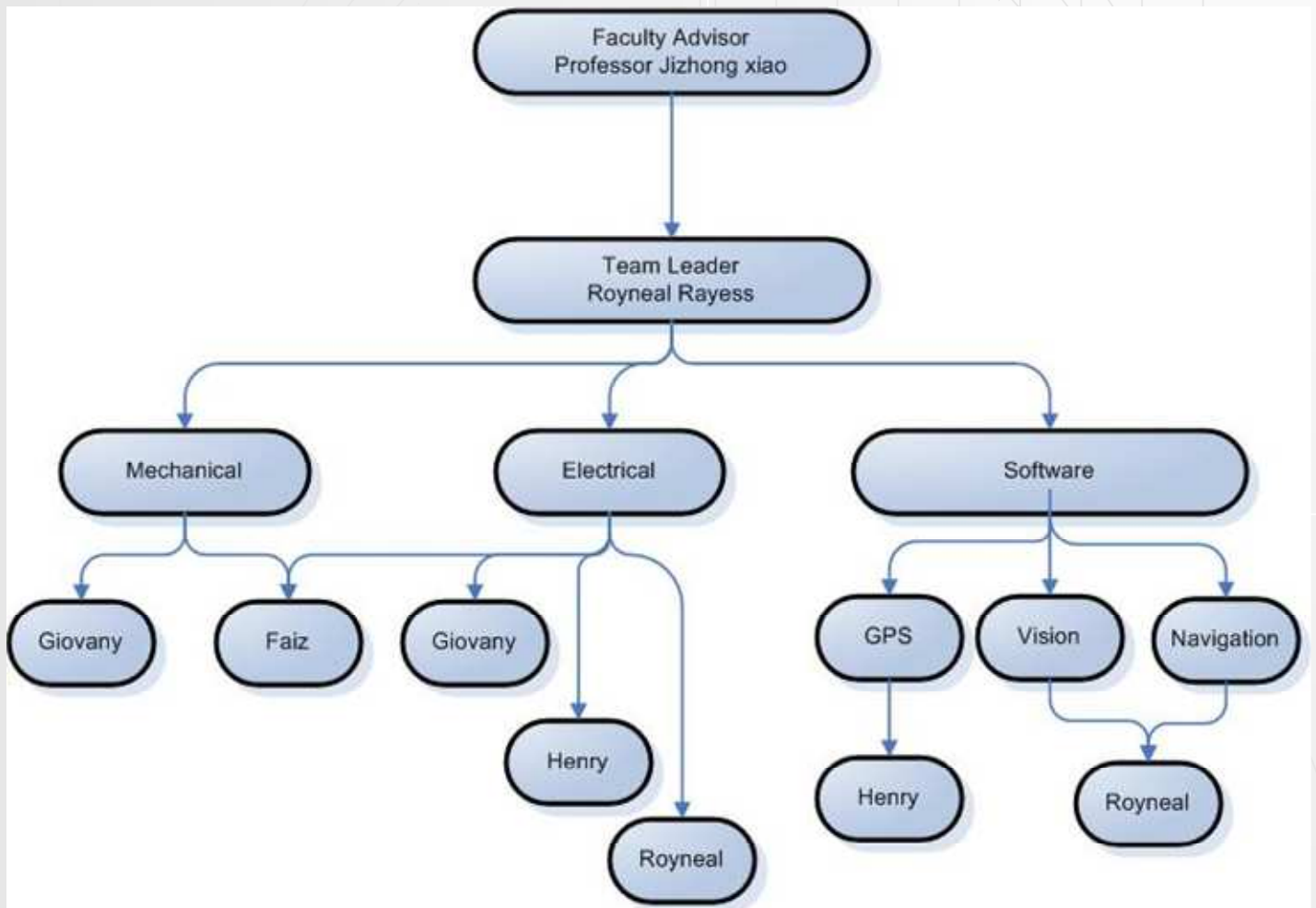

1.2 Design Innovations

As the team completes its fourth year, we have brought new innovations to the design of our vehicle. First is the arc method, utilizing three arcs centered around the robot which provide early obstacle detection and a dynamic behavior. The software also has the capability to interact with the GPS and guide the robot to the specified coordinates using a virtual vector method. Another addition is the audio visual interaction with humans. We have supplied the robot with blinkers that change their blinking rhythm and give out audible messages in order to warn people of its heading and its operating status.

Design Breakdown

2.1 Electronics

On CAP10, there is a single homemade board, which serves as a controller over minor elements in the robot. The circuit consists of a number of transistors, and relays which are controlled by a Pic 18 microcontroller. The microcontroller interfaces with LABVIEW in order to allow us to command the board to change its functions.

The board controls the fans and air flow inside the robot, to maintain proper operation temperature and prevent over heating of equipment. This board also generates the lighting sequence for the blinkers installed. The board also senses several power points and e-stops in order to signal the status of the robot to the user via LED's on the dashboard.

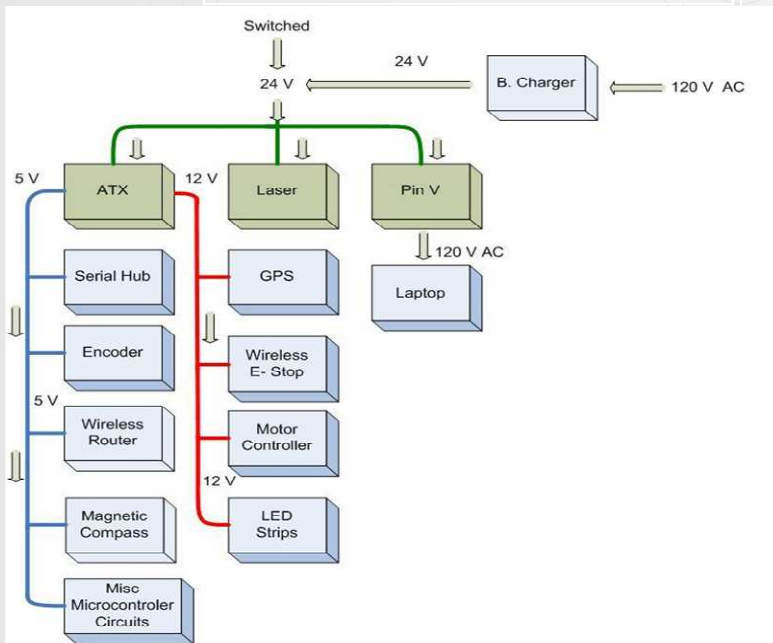
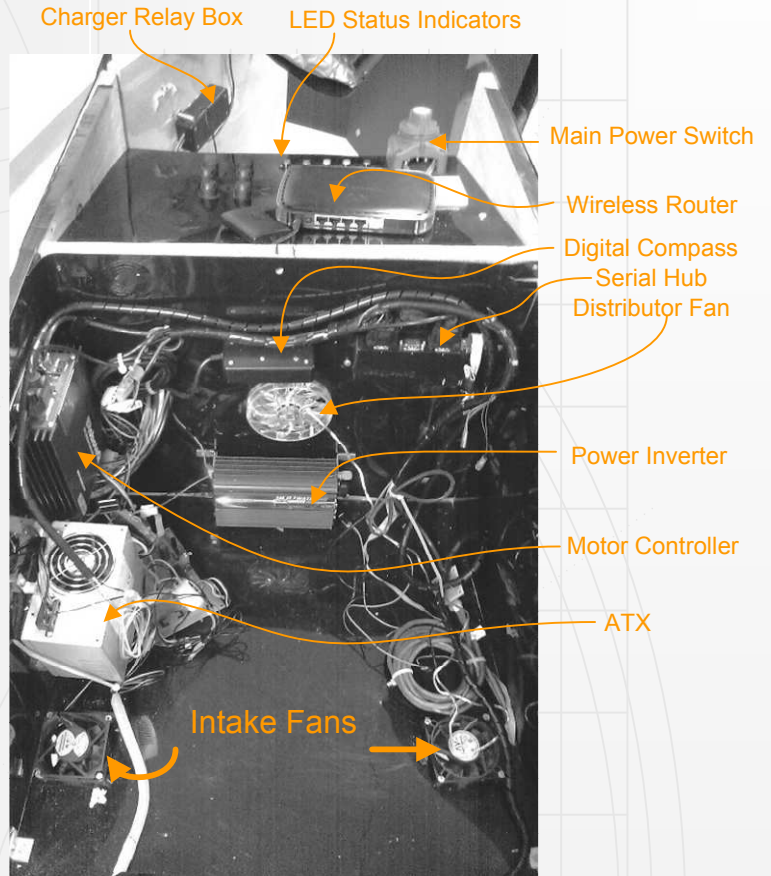

The rest of the equipment onboard are ready-made electronic DC devices, either running on 5V, 12V or 24V, such as DC-DC converters and DC-AC converters, Ethernet wireless router, motor controller, Laser Measurement system, magnetic compass, GPS and encoders. These devices are all sensors that will be discussed in the Sensors section.

These devices are located in the front of the robot along the walls of the compartment. They are distributed in such away to allow for easy servicing. The image above shows their locations and to the right we can see their power requirements.

Design Breakdown

2.2 Electrical System

Our electrical circuitry delivers 24V from two (2) 12V car batteries wired in series. The 24V reaches a main power switch, a circuit breaker, analog Ammeter and analog voltmeter before it is distributed onto the rest of the system. The 12V and 24V is fed into the rest of the devices, with the system also having an external charger that is plugged into the robot to recharge it. In order to protect the circuitry from any surges or short circuits, a set of relays disconnect the main power from the system when a charger is connected to the robot. Please refer to the diagram to the right. The wiring is properly rated to handle at least twice as much the rated current under normal operation.

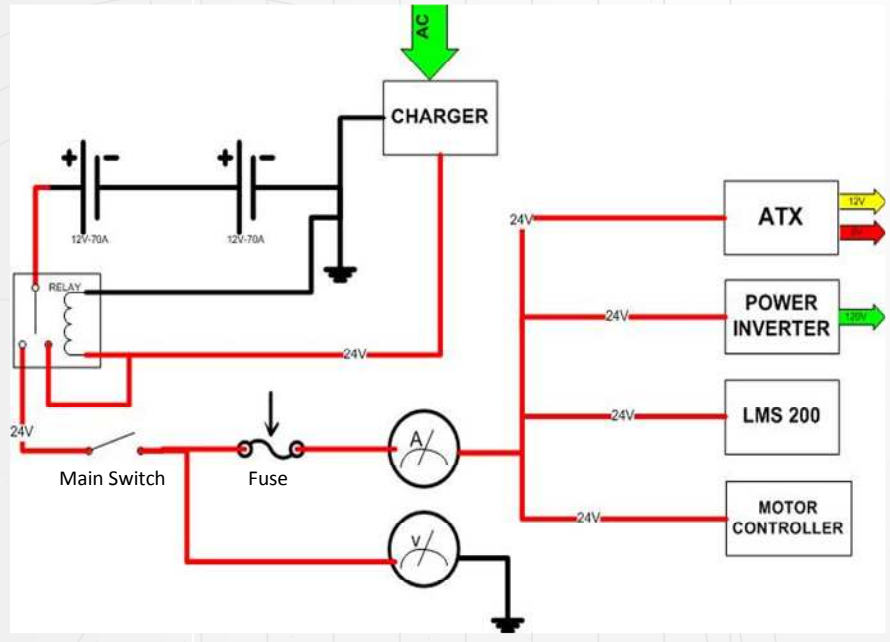

Power distribution circuit

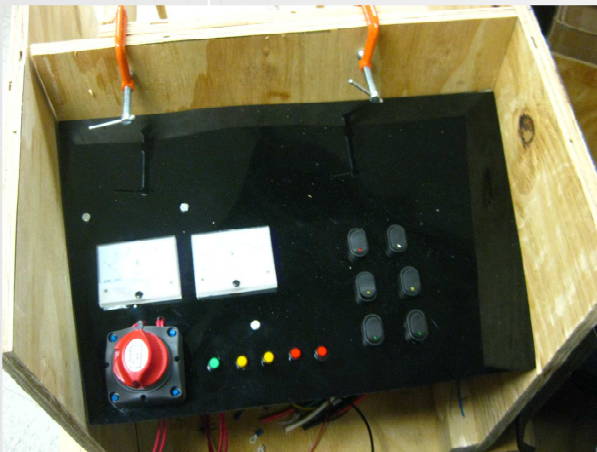

We constructed our main control board in such a way to make it easy to add any power components we also considered using black on purpose to create contrast to help viewing the LED's during midday outdoor operation. We placed the control board at the top rear of the robot to allow easy access in case of emergency.

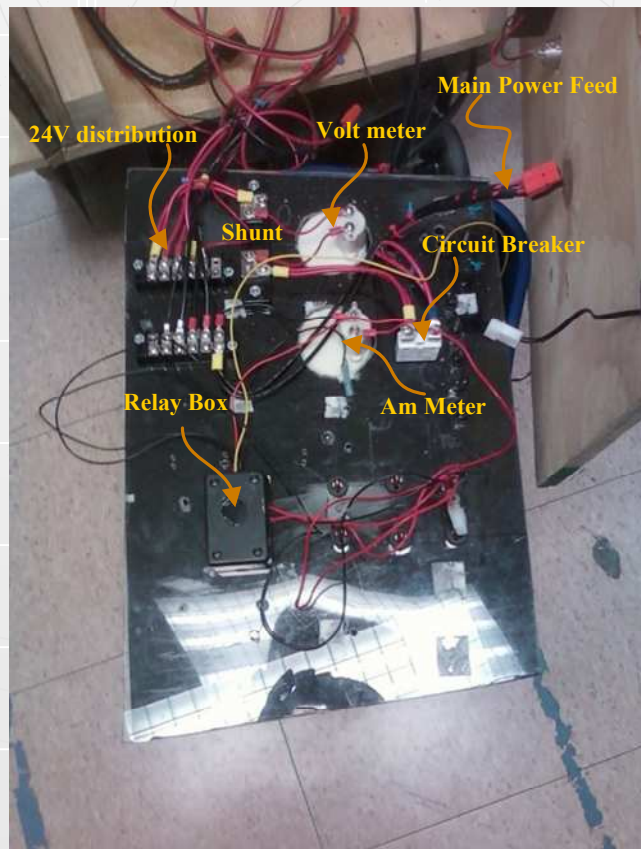

Design Breakdown

2.3 Actuators

In previous years, our teams have constructed many parts of the robot from the ground up, spending lots of effort and man hours into research, planning, and construction of the mechanical chassis. However, for CAP10 we have chose to use a well manufactured power wheel chair base. This provides the robot with a well tested, strong, fast and sturdy base that permits the robot to perform better and prevents mechanical problems. One other advantage of this wheelchair base is the ability to disengage the mechanical drive from the wheels; which provides an extra layer of protection.

Image of Robot Base



2.4 Sensors

Encoders

We are using H5D-32 from US-Digital, 2-channel quadrature encoders. These encoders mount on the shaft of the motor with a secure connector that is easy to plug-in. These encoders are capable of tracking up to 5000 pulses per revolution. Our encoders feed straight through to the motor controller which continuously provides feed back to our control software.

Encoder



Digital Compass

Our robot relies greatly on the digital compass to keep track of its orientation. We previously tried using the encoders to calculate orientation however it on rough surfaces the method is not reliable. We chose the PNI-FieldForce TCM XB which has sub Degree accuracy and provides tilt and acceleration in all three axis. The sensor does not have any lag in data transmission and maintains reliable accuracy unlike other sensors that drift after prolonged operation.

Compass



Laser

For several years SICK has been the choice of active sensing for the CCNY teams. This terrific sensor has a 80m range with 1 degree accuracy. The LMS200 is our Main source of obstacle detection. We use this sensor to locate obstacles that physically rise above the surface of the ground. With LMS200 we can construct a local map that is very accurate and is continuously updated allowing for real time operations.

Laser



Camera

For vision, we retrofitted a Logitech camera with a wide angle lens. This allows the sensor to view both lanes simultaneously most of the time. The camera is simply used to locate the lanes and potholes on the grass. Failure of this sensor will render the robot a lost obstacle avoidance device.



Design and Planning

3.1 Mechanics and Structure

Our objective is rapid development and optimization, in order to achieve a functional vehicle with a safe system that can be improved on a daily basis. To realize this goal, the 2010 first model of CAP10 was constructed from wood and plastic. The chassis of the vehicle is a DC-powered wheel chair. The vehicle takes a shape of a small car with a trunk in the front and a hood that pops open, exposing the entire interior of the robot, as shown in the image below, allowing for easy servicing and payload placement. The dimensions of the robot are a balanced mix of height and width in such a way that we have just enough space to nicely house all the required electronics and payload.



Plastic Framework of Main LED Headlights

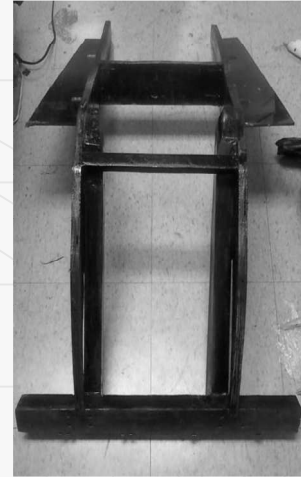

Black Framework of top hood



We have also decided to equip the robot with strong lighting for night operations based on previous experiences where testing was required at various times of the day. The design also takes into consideration weather proofing. The wood is completely covered with plastic to seal it off and allow it to operate in all weather conditions. The robot is divided into two compartments. The rear compartment holds the control board and computer, while the front compartment carries all other electronic components along with the payload.

3.2 Safety - Damage Prevention – E-stops

We exercise safe practices in our work to prevent injury to individuals and damage to the equipment. There are several layers of E-stops installed on the robot. First, a large mechanical E-stop in series with a wireless E-stop that cuts power directly towards the motors. The software, by default when it is started, requires the user to push a big red button on the GUI to activate communication with the motor controller. The motor controller itself requires a continuous pulsing signal to it to maintain a certain speed. Otherwise, it shuts off power automatically and the motors halt. In addition, the mechanical clutch disengages the motor drive from the wheels. This is very helpful and is used for preventing accidental wireless activation while the robot is on and in stand by.



Design and Planning

B. Safety exercised with Blinkers and Audio Interaction

We intend to make our robot interact with its environment. This project exists and functions on a college campus, which is an environment highly trafficked by students and visitors. We realized that flashing blinkers is rather aesthetic moreover than a means to function. As such, in case the robot is left alone on standby for any reason, the blinkers will be fading in and out smoothly until a human comes near at the point which the blinkers start flashing with a fast rhythm and a message is relayed verbally through speakers to the object to maintain distance. In case we are in transition or operating off grass, the robot indicates verbally its heading, along with the blinkers flashing with an aggressive rhythm. These dynamics improve the interaction with people and spectators without having us tell everyone to move out of the way or keep a distance.

3.3 Software



A. Control and Interfacing

Our objective is to construct a platform for rapid development and optimization. To achieve this in the programming department, we based our software on LABVIEW, which grants us easy generation of user interfaces, and provides a multidimensional programming environment where the platform can interact with other programs internally or externally, via TCPip or interact with devices using the Serial or USB ports.

Our sensors and motor controller are all connected to the Serial port, through which we establish communication and feedback loops into our control algorithm.

Design and Planning

B. Obstacle Avoidance

MULTI RANGE ARC DETECTION METHOD

The method has a basic algorithm (called the pilot) for common easy obstacle avoidance and a more advanced algorithm (called the co-pilot) to extract the robot from traps. The method also considers the dynamics and kinematics of vehicles in motion and aims at generating smooth transitions between states, without generating abrupt changes in heading, oscillations or stopping to acquire readings about the surrounding as previous methods did.

Multi Range Arc Detection uses a local map, which is a two-dimensional array representing the world in front of the robot. The robot is placed at the bottom center of the map with a set of three virtual concentric arcs centered on it. The arcs provide information on the number of openings available, their size, location with respect to the robot, and the density of obstacles and how far they are. Based on that information the robot changes its behavior. It could move fast forward and make shallow turns when a low obstacle profile exists, or move slow and make sharper turns when obstacles are cluttered and too close. We have developed two methods discussed below and we compared the results.

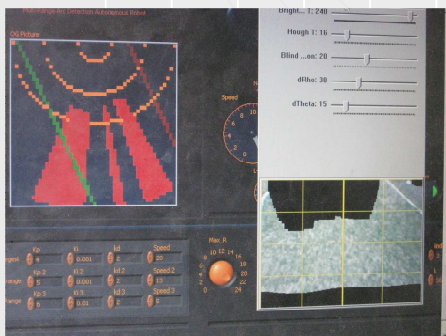

Snapshot of the computer screen with the software running

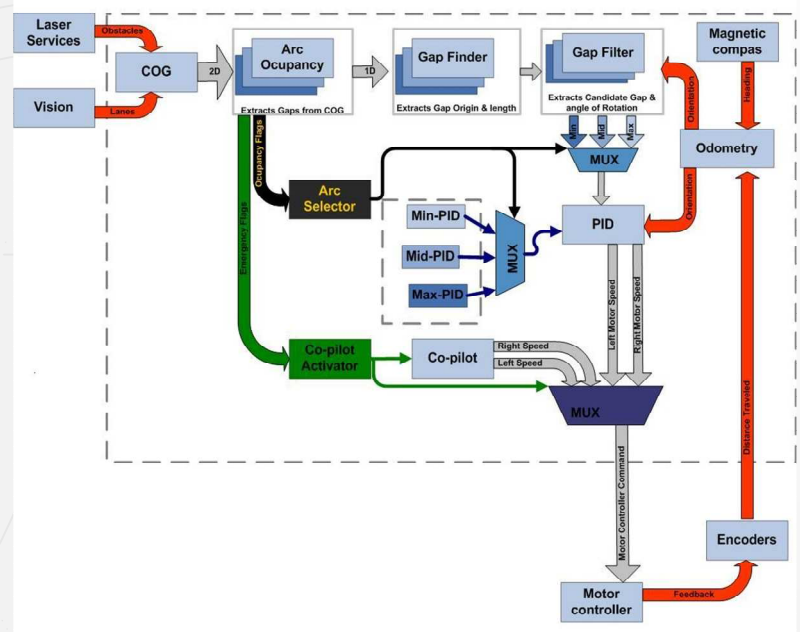

A. THE ONE ARC ALGORITHM:

The algorithm simply probes for obstacles along the perimeter of the arcs. When an arc is intersected by two or more obstacles, arc sections are formed. These arc sections are the potential openings between obstacles. The length and starting point of the arc is stored in two one dimensional arrays. These arrays are then filtered based on the width of the robot and the opening that requires the smallest angle of deviation. Openings are also filtered based on whether they fall inside or outside the road lanes generated by the computer vision. After the final opening is chosen, the angle of deviation is commanded to the motor controller and the robot aligns itself with the center of the opening as it is approaching it in real time.

Design and Planning

B. THE MULTIPLE ARC ALGORITHM

In order to improve results, the algorithm was reconstructed with three arcs. Each arc has different speed and PID parameter associated with it. Each arc on its own behaves as described in the one arc algorithm section, however with its own preset parameters. The arcs are given hierarchy, from center out. The robot will respond to closer obstacles intersecting the inner arcs before it responds to farther obstacles detected by outer arcs. The parameters for the outer most arcs are set and tested based on spaced out obstacle settings. While the inner most arc parameters are set to most critical and high response tight fit situations. The middle arc is an intermediate solution for both extreme cases and it is usually the most active of all three arcs. The layering of arcs was tested and showed significant improvement over the single arc algorithm.

The initial approach of a one arc algorithm avoided various obstacle formations including switchbacks. However it often collided with close by obstacles as it avoided farther away ones. This result has led us to develop multiple arcs in order to expand the number of obstacles that can be tracked at once. By introducing three arcs, that trigger different dynamic behavior of the robot, we were able to solve the limitation of the one arc method and avoid even more difficult static and dynamic obstacles. The improvements allowed the robot to traverse the obstacle course making adjustments to its speed and rate of response before it reaches obstacles and as it passes through, which permits for continuous and more effective correction to the trajectory and successful obstacle avoidance.

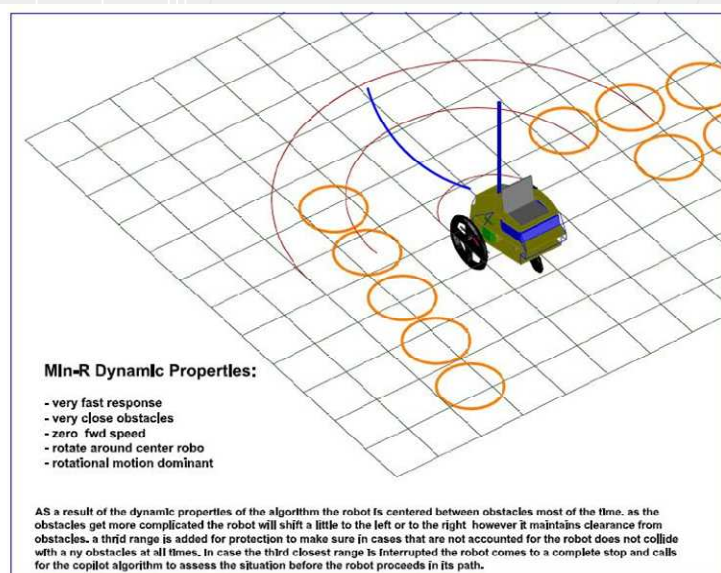
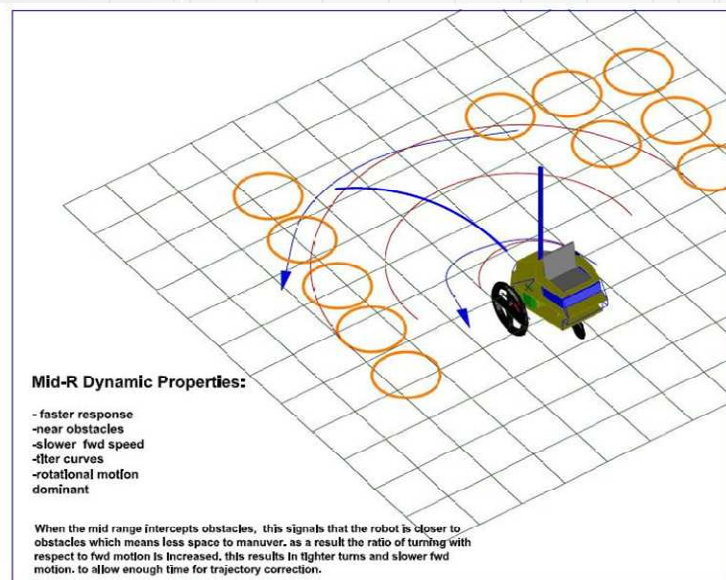
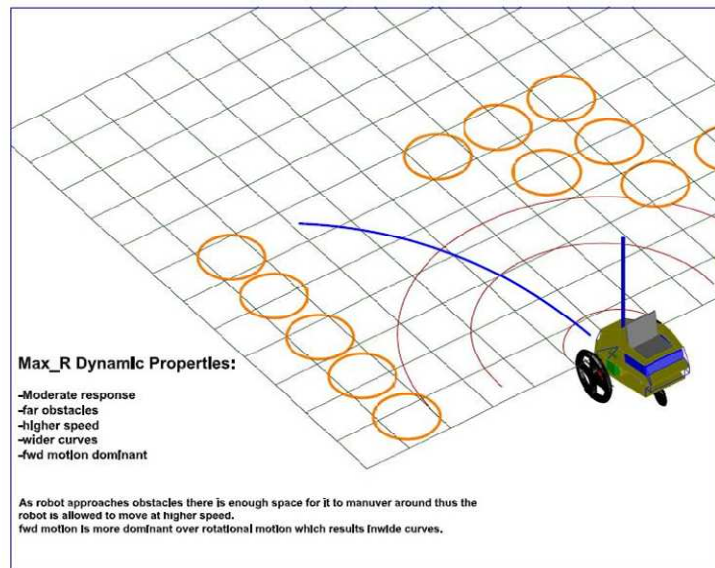

Design and Planning

C. Simulator

Our simulator was a key factor in the success of the control software. While the actual testing is time consuming and exhausting and limited by weather conditions and daylight, the simulator allowed for rapid development with no limitations. The simulator is also based on Labview it is simply a virtual instrument that functions by sending virtual data to the control software based on an image that we draw, the control software reacts to it and commands the simulator. The simulator was very valuable as it allowed us to test many different terrains in less time and with very little effort.

To the right we can see a snap shot of four consecutive frames of the simulator showing the robot functioning with one arc. In the pictures we can see the robot to the right approaching an obstacle and to the left we can see the laser screen. As soon as the obstacle touches the yellow arc, the robot starts moving away to avoid it. We can see in the last frame that the robot cleared the obstacle.

Below we can see an entire field, the robot is in the lower right corner preparing to enter a switchback.

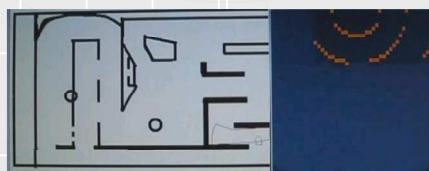
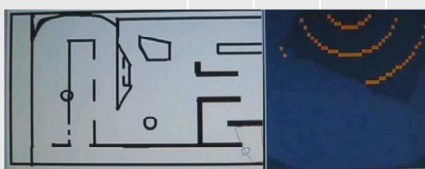
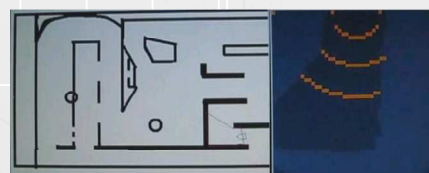
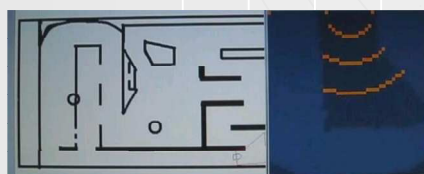
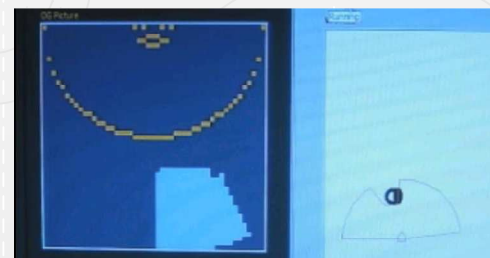
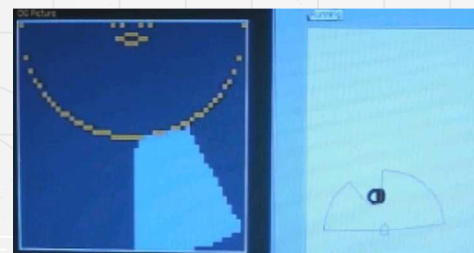
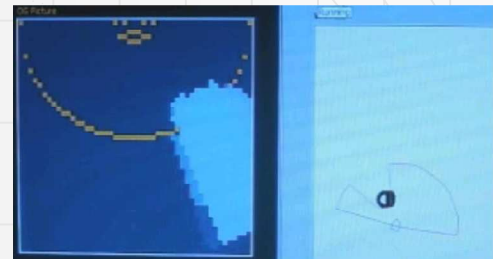
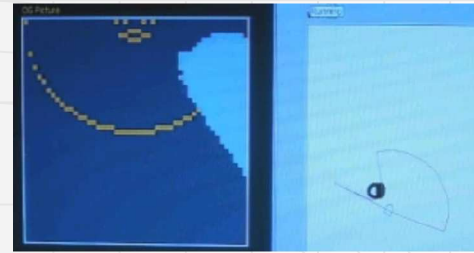

We can also see how the arcs interact with the boundaries. The algorithm runs smoothly in the simulator as well as in the real world. The simulator does not account for some physical factors like friction, which requires different PID calibration, however that does not create much discrepancy in results.

Design and Planning

3.3 Vision

Our vision algorithm utilizes the Labview vision toolbox to make it easier to integrate with the rest of the system. We are using a simple algorithm that depends on 5 boxes evenly distributed over each side of the screen. The image obtained from the camera is reduced to 400x400 pixels to reduce the amount of processing. Then 10 boxes, 5 on each side, continuously scan for a certain density of black pixels in separate screen halves. When this density is located pixels lock on that position and then their geometric relationship is checked to determine whether a lane exists or not.

The algorithm further divides the screen into four quadrants in order to track patterns that occur often between these 10 squares.

There are three major cases that the algorithm is concerned with. First obstacles that show at the center or the side between lanes, second lanes that cross from right to left or of the screen or vice versa and third cross roads.

It is often the case that a box locks onto an obstacle (figure.3) or perhaps several boxes lock onto an obstacle as shown to the right. This of course creates false line detections. Therefore in order to avoid this problem, detected lines are checked against previously detected lines to ensure continuity and reliability. As well as the lines are checked to fit certain criteria depending on where they fall in the screen.

In figure 2, we can see the lane crossing from left to right in such cases there is always a quadrant that has in active boxes marked red. Such a case is a marker that indicates lane migration. Many other similar markers and box patterns have been observed and preconceived in the algorithm to filter out objects.

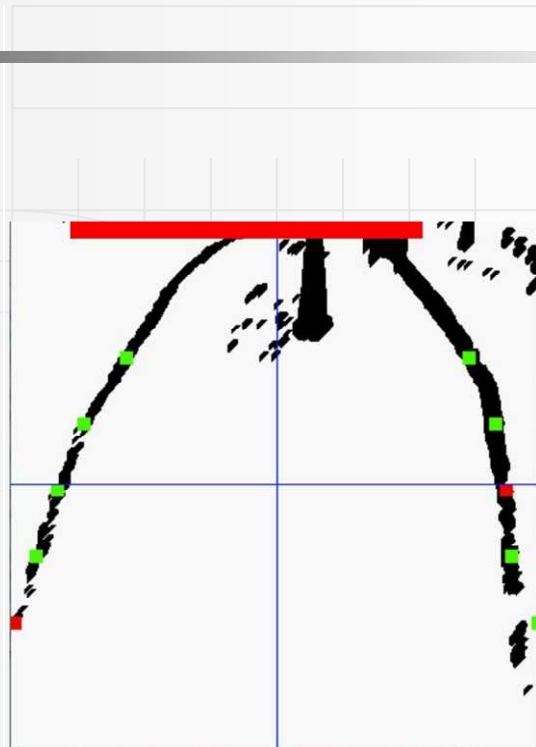

Figure.1

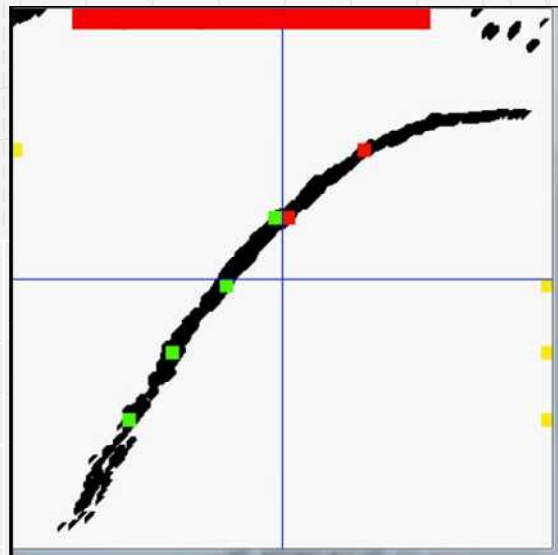

Figure.2

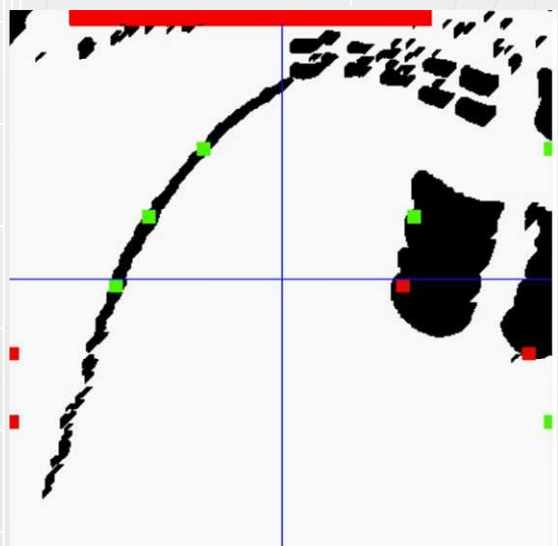

Figure.3

Conclusion

4.1 Cost

Throughout the development of CAP-10, we were committed to keeping the cost down as much as possible. Many of the parts listed below were obtained off the shelves from the robotics labs. We tried saving most of our budgets to obtain high quality sensors, such as the PNI compass.

Item	Cost
Wheel Chair	\$ 3000.00
Batteries	\$ 200.00
DC Motor Controller Roboteq	\$ 500.00
GPS NovAtel	\$ 3000.00
Sick Laser LMS 200	\$ 5000.00
Serial Hub	\$ 200.00
FieldForce Magnetic Compass	\$ 1300.00
Camera	\$ 60.00
Encoders	\$ 160.00
ATX	\$ 500.00
Power Inverter	\$ 200.00
Electronic Parts	\$ 150.00
Construction Material	\$ 300.00
Total	\$ 14,570.00

Conclusion

The City College of New York students from the robotics' team has re-designed, re-built and tested its new improved autonomous ground vehicle CAP10. We believe and have high expectations that our simple design vehicle CAP10 will perform successfully in this year's Intelligent Ground Vehicle Competition. Our team has succeeded with this year's goal which was to improve and reengineer ELVIS by making it a more reliable and a smarter autonomous system.